

BUILD IT WITH  
**REDWOOD**

Lake Tahoe Gazebo



**R E D W O O D**

Naturally beautiful  
Easy to use  
Practical and economical  
Durable and stable  
Resistant to decay and insects

# Lake Tahoe Gazebo

## BUILD AN OUTDOOR RETREAT

Extend your home's living space into the garden with an elegant and easy to build eight-sided redwood gazebo, a pleasant outdoor retreat for social gatherings or soothing private reflection.

Construction Common and Deck Common are excellent economical redwood grades for this project. They are easy to work with and accept a variety of finishes. Where increased decay resistance is needed, use all-heartwood grades: Construction Heart or Deck Heart.

This project requires careful planning and measuring during construction of each of its main components: layout, posts and footings, decking, frieze, rafters and roofing, and railings.

If you are a relative newcomer to do-it-yourself projects, follow the construction steps presented here and seek help whenever you are unsure of the details. More experienced d-i-y-ers will feel comfortable with this basic design and will find several areas to add personal touches. A few ideas for frieze, railing and roofing options are offered later in this brochure.

Use corrosion-resistant hardware. Check local building codes before planning construction.

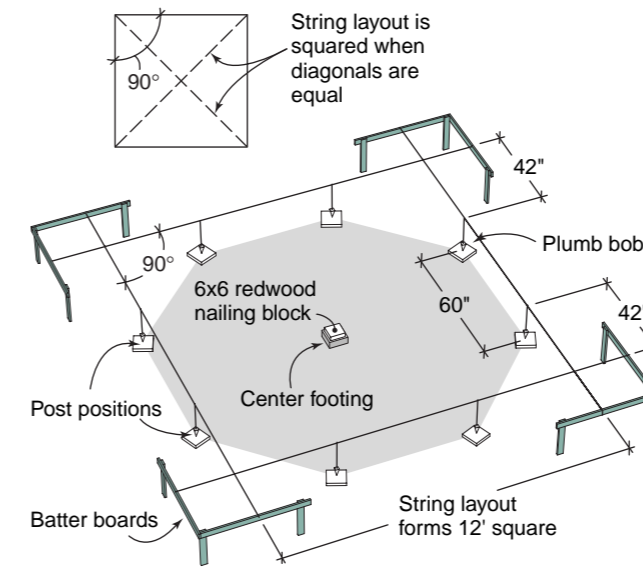
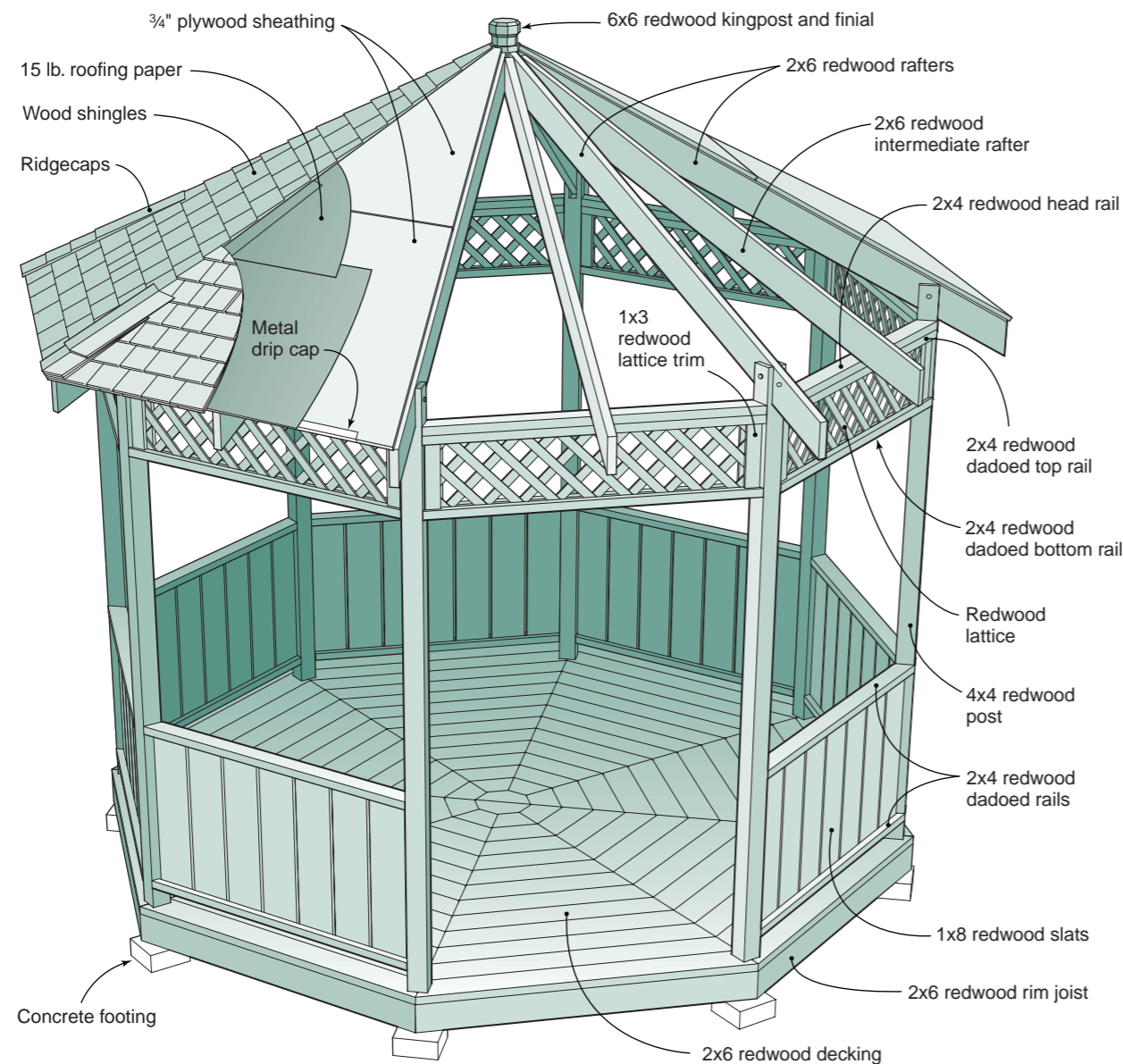

**Layout** If you think of an octagon as a square with its corners cut off, you'll realize how simple the shape truly is. A common measurement and trim angle to remember throughout the layout and construction process is  $22\frac{1}{2}^\circ$ . The key, as with any project, is both careful planning and precise measurement.

At a level building site, use batter boards and string to lay out a square twelve feet on each side. To check for  $90^\circ$  corners and to find the center of the gazebo, run strings from corner to opposite corner. The square is true and its sides are parallel when the diagonal measurements are equal.

Where the two diagonal strings cross, drive a stake into the ground to mark the position of the center footing.

Once squared, make a mark along each string 42 inches from the corner in both directions. Use a plumb bob and chalk to transfer each mark from the string to the ground, and drive a stake to mark the center of each post position. The measurement from post center to post center should be 60 inches.

**Footings** Snap chalk lines from post stake to post stake to create the gazebo outline on the ground. Remove the string from one side of the layout at a time while you dig the holes for the concrete footings. Do not remove the batter boards yet, as you will need to restring the gazebo layout later to help set the post anchor bolts.

The footing holes should average 12 inches in diameter, be at least 3 feet deep and be larger at the bottom than at the opening. Fill the base of the hole with several inches of compacted gravel. In cold climates, footings should extend 6 inches below the frost line or comply with local codes.

Make 12- by 12-inch square wood frames from 2x4 lumber for each footing to contain the concrete at ground level. Restrict the gazebo layout now so that the frames can be centered for positioning the anchor bolts and posts later. Level the frames to each other and use backfill or stakes to secure the frames while pouring the concrete.

**Post anchors** Use adjustable post anchors and quick-setting concrete. Pour the center footing first and set a 6-inch-long 6x6 wooden nailing block at a depth of several inches into its center so that at least four inches remain above the concrete. Trim this block to height later when framing in the deck.

Pour perimeter footings and set anchor bolts one at a time. All anchor bolts should measure six feet from the center of the gazebo and five feet from each other. Check each for plumb and level. This is important for the gazebo to properly fit together. Make any adjustments before the concrete sets completely—about  $\frac{1}{2}$  hour.

Once the concrete is set, assemble the post anchors square to the center footing and with the required  $22\frac{1}{2}^\circ$  angle between posts. Remove the 2x frames.

**Posts** The decay-resistant redwood grades, Construction Heart or Deck Heart, are ideal choices for the posts. Cut a notch  $\frac{6}{16}$  inches deep and  $1\frac{1}{2}$  inches wide in the top ends of each 4x4 post for attaching the roof rafters (see detail in rafters section). Trim the 4x4 posts to 9 feet 5 inches.

Cut a double bevel of  $22\frac{1}{2}^\circ$  beginning  $5\frac{1}{2}$  inches from the bottom. Attach posts to footings at each metal post anchor with 10d nails. Offset the posts toward the center of the gazebo and make sure the beveled edges clear the sides of the post anchor so that the rim joists can be attached later. Plumb and brace posts.

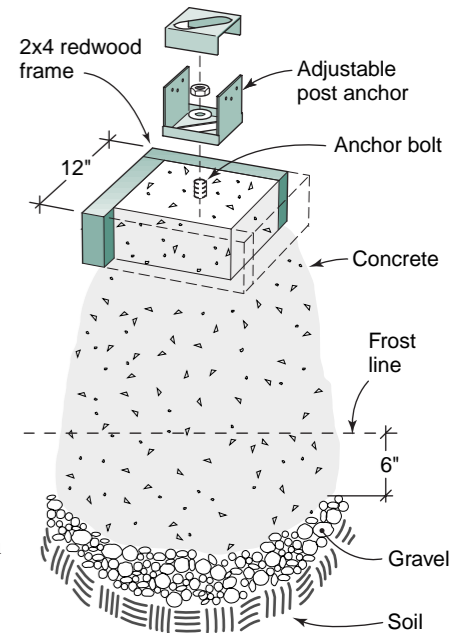



## FRAMING AND DECKING

The deck framing is constructed near the ground, so use Construction Heart or Deck Heart grade redwood. Use corrosion-resistant deck screws, nails and metal joist hangers.

**Deck joists** Measure and trim a single 2x6 redwood joist to span the width of the gazebo between opposite posts. Use a string level to guide you in attaching the metal joist hangers to the posts with 10d nails. Trim the center nailing block to height so that the spanning joist will sit on it. Secure the spanning joist to the posts and toenail it to the center nailing block.

Two deck joists meet the spanning joist at 90° and are installed first, followed by four 2x6 deck joists that attach to each post. Double check these and all other joists for level.

**Headers** Trim ends of 2x6 headers to opposite 22½° angles. Use 16d nails to attach the headers to the deck joists where the joist span becomes greater than 24 inches and where a whole deckboard will cover them.

**Rim and intermediate joists** Trim 2x6 redwood rim joists with 22½° opposite angles. Attach rim joists to the outside of the beveled posts with two four-inch, self-tapping deck screws per joint. Measure and trim the remaining eight intermediate joists to run from rim joists to headers. Attach with joist hangers.

**Decking** Install 2x6 deck boards with two deck screws or 16d nails per bearing. If you use nails, predrill holes at board ends to prevent splitting. Choose Construction Common or Deck Common redwood, grades with pleasing blends of heartwood and sapwood, for a long-lasting and economical deck.

Start the decking installation at the rim joist and notch the first row of deck boards to fit around the posts. The deck boards should trim to 22½° at their ends to butt join at the centers of the deck joists.

To ensure accurate trims and spacing, lay out the first section of deck boards without trimming or nailing them. Snap chalk lines across the boards along the centers of the deck joists to mark the end cuts and nailing patterns. Use a 16d nail to space the boards. Nail heads should be flush with the board surface.

At the center of the deck, finish with a full course of deck boards and an octagon created from two halves cut from pieces of 2x6 lumber.

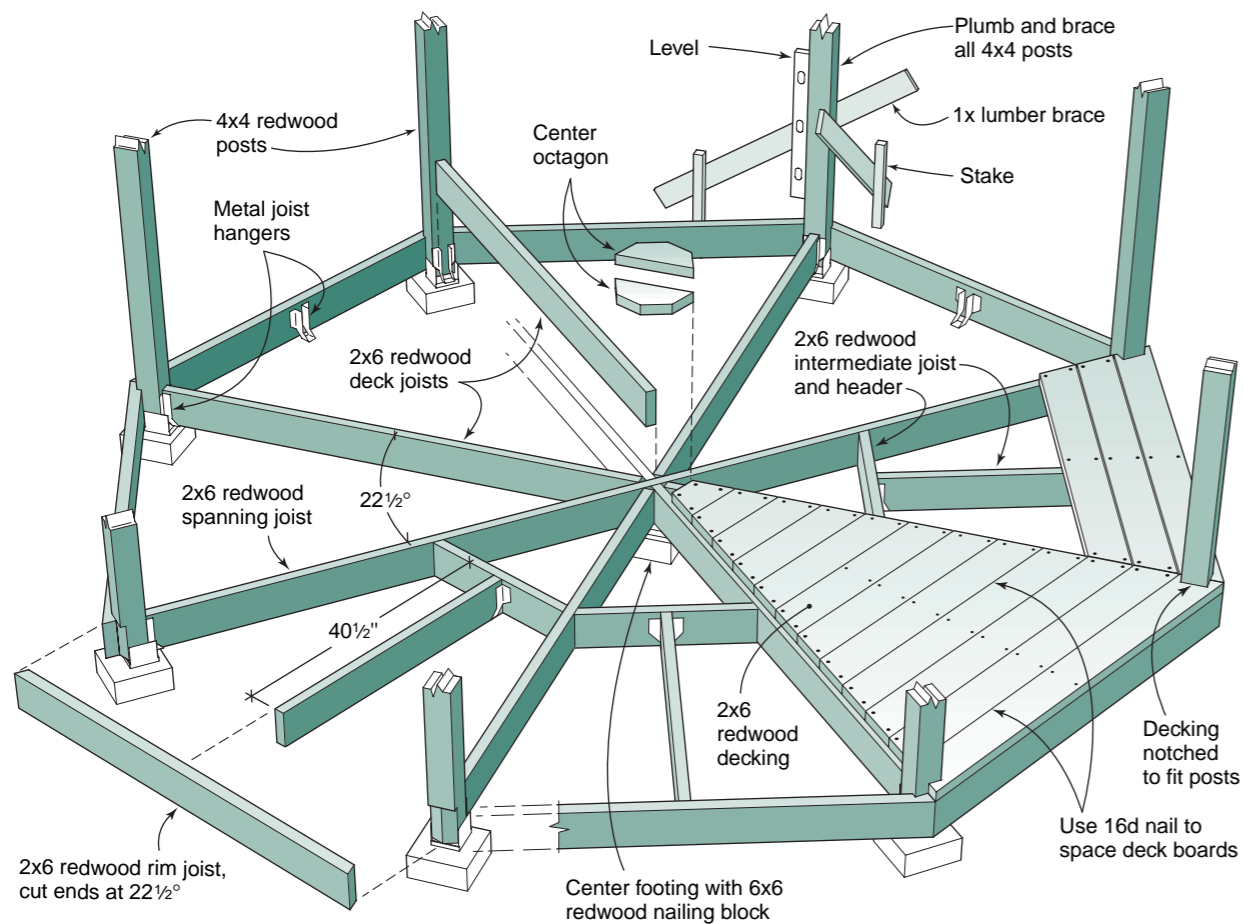

## FRIEZE AND RAFTERS

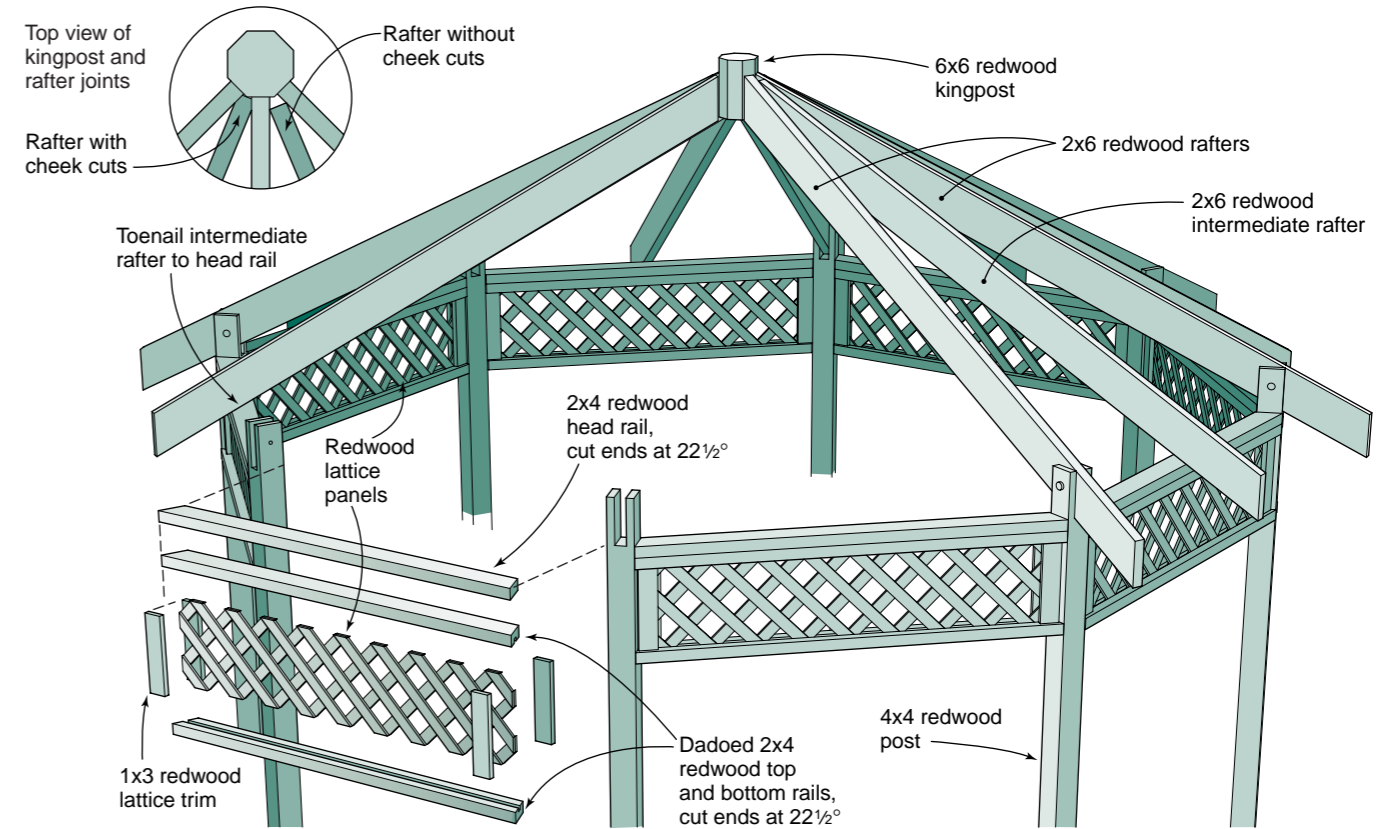

The frieze is a decorative element which can be constructed to match the railing design or a design element of the home. Since this frieze also supports some of the weight of the roof, it is constructed with a combination head and top rail.

**Lattice** Ready-made ¾-inch redwood lattice panels are trimmed to 12 inches wide by length needed—about 56 inches.

**Rails** Use premanufactured dadoed 2x4s for the top and bottom rails. Trim all rails to length with opposite 22½° angles where they attach to the 4x4 posts. Measure each post-to-post section separately, measuring from the outside edges to ensure a snug fit. Drill ⅜-inch drain holes in the bottom rails every 8 inches to prevent water damage.

Secure the head rail to the top rail with four 2½-inch screws driven from the top rail into the head rail on both sides of the dado. Insert the lattice panel into the top and bottom rail dadoes and secure with 8d finish nails.

Assemble the frieze sections on level ground, and against a straight edge to keep them square, before toenailing them to the 4x4 posts. Complete the frieze with four trimmed-to-fit 1x3 redwood boards toenailed to the rails with finish nails.

The sixteen 2x6 redwood rafters join a 7-inch long octagonal 6x6 kingpost at the peak of the gazebo roof.

**Kingpost** Cut the kingpost using a table saw, or buy a ready-made one. The eight main rafters trim to about 98 inches long with 26½° parallel cuts.

**Rafters** Attach two rafters to opposite sides of the kingpost. Center this assembly atop the gazebo with the rafters' running ends set into the post notches. Drill pilot holes through both the rafters and the posts. Secure with 4-inch bolts.

The eight intermediate rafters trim to length after installation. Cheek cut and nest them between the main rafters at the kingpost. Toenail the running ends to the head rail.

Remove bracing from the posts.

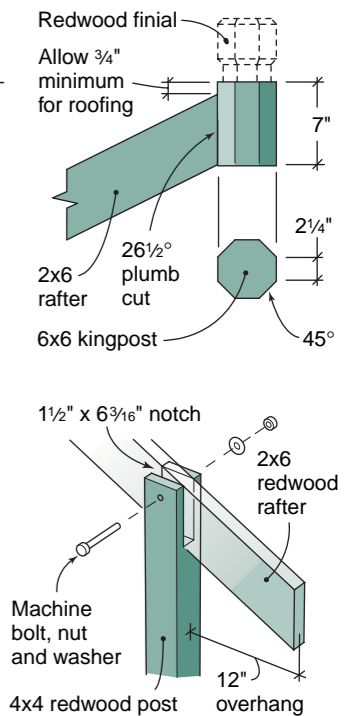

## ROOFING

A variety of roofing options are available and three styles are discussed here. Redwood slat roofs are economical, easy to install and offer varying degrees of protection from the sun. Wood shingles can be installed over a paper and plywood base or can be nailed directly to spaced slat sheathing which is constructed similarly to the slat roof. Shingled roofs offer full protection from the sun and rain.

**Redwood slat roof** Slat size, spacing and angle determine the amount of light and sun exposure inside the gazebo. For the fairly exposed design shown here, use one of the 1x4 redwood slats for 3½-inch spacing. Premeasure and carefully mark the rafters with slat positions for faster and easier installation. Snap chalklines down the center of the rafters to guide the 22½° slat-end trims. Nail the slats directly to the rafters using two 8d nails per bearing. Pre-drill holes at slat ends to prevent splitting.

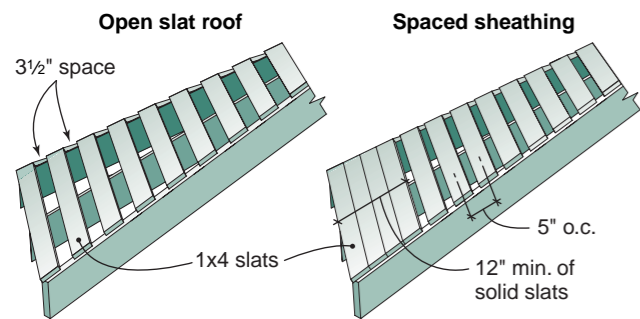

**Shingles over spaced sheathing** Follow the basic slat roof construction steps. Add two more slats at the roof's edge to simplify installation of the starter course. Space the rest of the slats five inches on center or to match the weather exposure. Other installation details are the same as for shingles installed over plywood sheathing.

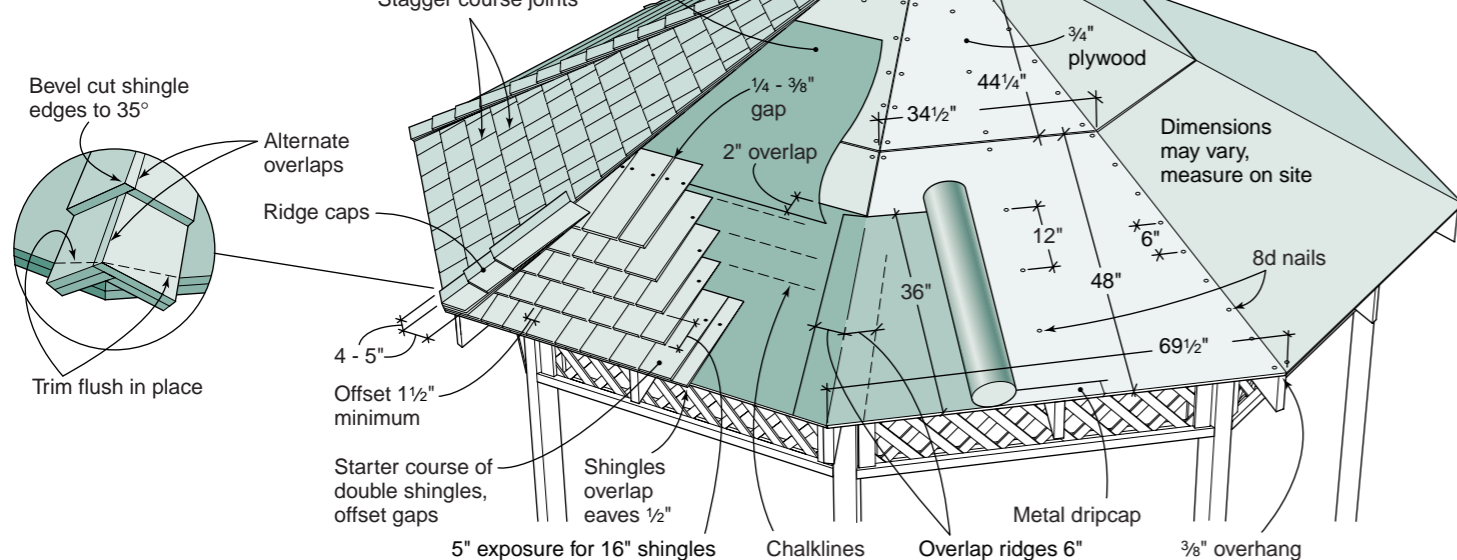

**Shingles over plywood sheathing** Each two-piece section of sheathing is cut from one 4x8 sheet of plywood. Use 8d nails to install the roof panels, allowing ⅛-inch expansion gaps at the joints. Attach metal drip caps at the eaves.

Lay and staple 36-inch wide roofing paper in layers as shown. Begin installation with the starter course made up of a double row of shingles overhanging the sheathing by ½ inch. Snap chalklines to ensure that additional courses are installed in straight lines. Weather exposure should be slightly less than one third the total length of the shingle. Stagger the gaps at least 1½ inches and leave ⅛- to ¼-inch spaces between shingles.

Nail shingles with two roofing nails approximately ¾ inch from each edge and 1½ inches above the butt line of the next course. Nails must penetrate at least ½ inch into the sheathing. Use longer nails on the ridge caps to penetrate the sheathing.

Ridge caps are available ready-made for easier installation or make your own. They should be trimmed to 4-5 inches wide with a 35° bevel on one edge (see detail below). Install with alternate overlaps and with two nails on each side 6 to 7 inches above the butt edge. Finish at the peak with shingles trimmed to about 8 inches from the tail end.

**Finial** To prevent water damage to the kingpost and rafter joint, attach metal flashing to the roof peak before toenailing the finial to the kingpost. Caulk the joining edges and any exposed nail heads.

## RAILINGS

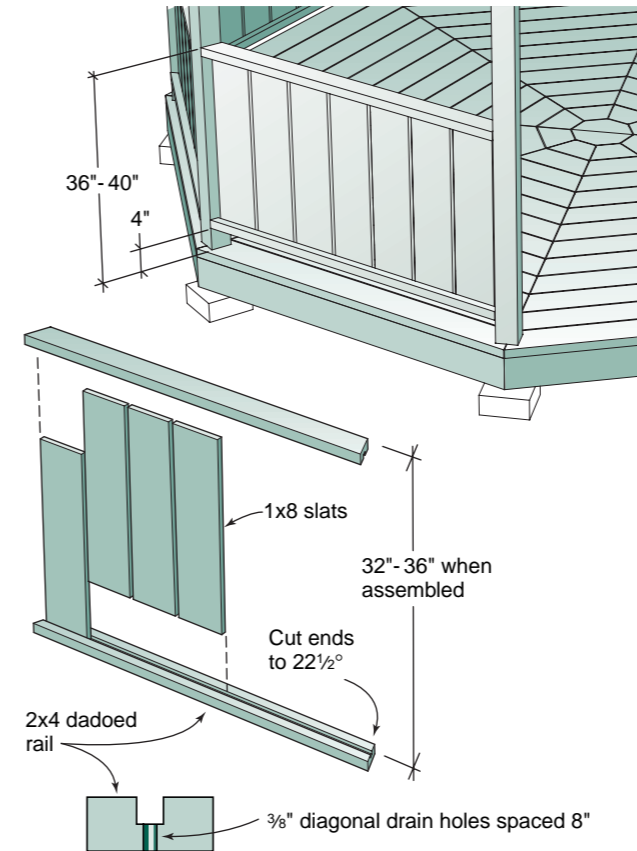

Custom railings and fills give a gazebo a distinct design personality because, next to the roof, they can be the most visible element. Wood railings and fills come in a few basic styles with almost limitless variation. From solid slat to cutout, from squared baluster to turned, choose a style that enhances the overall gazebo design. Follow the basic construction steps for solid slat railings or choose to use 1x1 nailing cleats as shown in the illustrations at upper right.

**Solid slat railings** Use ready-made dadoed redwood 2x4 rails to make railing construction easier. Nailing cleats can also be used to secure slats. Railing height from the deck surface should be 36 to 40 inches or conform to local building code.

Take the outside post-to-post measurements, and trim railing ends to 22½° or to match the post angles. Drill 3/8-inch diameter drain holes every 8 inches in the bottom dadoed rails. Cut the 1x8 redwood railing slats to at least 32 inches. Use 10d nails or 3-inch screws to attach bottom rails to the posts 4 inches above the decking. Insert the slats and cap with the 2x4 top rail secured to posts with 10d nails or 3-inch screws.

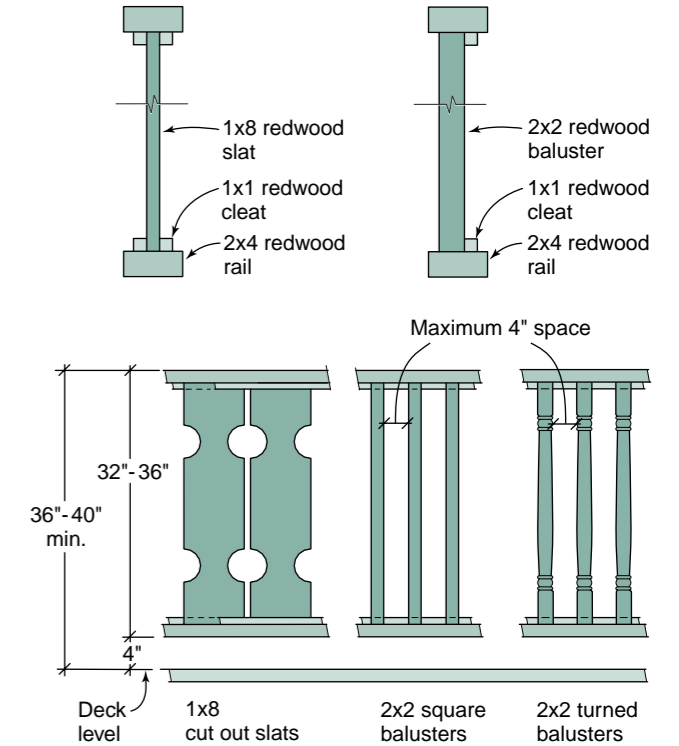

**Cutout slats** This style often expands on a custom design detail from the frieze and it can be as simple as the oval pattern shown above, or as elaborate as the gingerbread designs of the Victorian era. Create a template from hardboard and transfer the pattern to the 1x8 redwood slats. Use a band or saber saw to cut the pattern from several boards at a time. Secure the redwood slats to the rails with nailing cleats.

**Balusters** Squared or turned baluster railings open up a gazebo to its surroundings, while giving it both a traditional and elegant look. Ready-made, turned 2x2 balusters cost just a bit more than the squared balusters and some suppliers also offer matching posts. With the proper tools, you can create your own custom balusters of simple or ornate design. Use dadoed rails or nailing cleats to secure the balusters, and space balusters no more than 4 inches apart for safety.

You can also assemble baluster-style railings without using nailing cleats or dadoed rails. Drive 8d nails up through the bottom 2x4 rails into the baluster bottoms, and then carefully toenail the top of the balusters to the top rail, hiding the nailheads.

**Nailing options** The details above show two options for constructing slat or baluster railings with 1x1 molding used as nailing cleats.

**Sanding and finishing** Sand railings with medium grit sandpaper. Apply a water repellent finish.



## MATERIALS LISTS

The following measurements and quantities are guidelines only; measure and cut as you build. For guidance in specifying the right redwood grade for the application, read the Grades descriptions on the address panel.

**Tools you will need:** String, plumb bob, chalkline, post-hole digger, hammer, nail set, tape measure, circular, table and hand saws, carpenter's level, string and torpedo levels, framing square, adjustable and socket wrenches, power drill, roofer's hatchet, block plane, screw and staple gun, ladder.

Materials For Redwood Gazebo			
	Quantity	Size	Length
<b>Layout</b>			
Batter boards	8	1x2	3 feet
Wooden stakes	28	1x2	2 feet
Footing frames	8	2x4	28 lineal feet
<b>Framing</b>			
Posts	8	4x4	10 feet
Wooden braces	16	1x3	4 feet
<b>Deck</b>			
Deck joists	1	2x6	12 feet
	6	2x6	6 feet
	8	2x6	4 feet
Deck joist headers	8	2x6	3 feet
Deckboards		2x6	184 lineal feet
Rim joists	8	2x6	6 feet
<b>Frieze</b>			
Lattice rails	24	2x4	6 feet
Lattice	2	3/8	4x8 panel
Lattice trim	32	1x3	10 1/2 inches
<b>Roof</b>			
Kingpost	1	6x6	7 inches
Rafters	16	2x6	9 feet
Exterior plywood	8	1/2- or 3/4-inch	4x8 panels
Wood shingles	As needed		for 2 1/3 square
Roofing felt or paper	1 roll	36"x144 feet	
<b>Railings</b>			
Top/bottom rails	16	2x4	6 feet
Slats	64	1x8	32-36 inches
<b>Hardware</b>			
Deck screws	1 pound ea.	2 1/2, 3, 4 inches	
Nails	2 pounds each	16d and 10d common and 8d box or common	
Roofing nails	1 pound		
Roofing staples	2 pounds		
Joist hangers	24	2x6	
Post anchors	8	4x4	
<b>Miscellaneous</b>			
Pre-mixed concrete	As needed		
Gravel	As needed		

The following measurements and quantities are guidelines only. For best results, measure and cut as you build.

Materials For 1x4 Redwood Slat Roof (3 1/2" spacing)			
	Quantity	Size	Length
Slats		1x4	312 lineal feet
Metal flashing	1	12-inch square	
Nails	2 pounds	10d common	

Materials For 1x4 Redwood Spaced Sheathing (5" o.c. spacing)			
	Quantity	Size	Length
Slats		1x4	728 lineal feet
Nails	2 pounds	10d common	

Materials For 2x2 Baluster Railings			
	Quantity	Size	Length
Balusters, 3" spacing	100-126	2x2	32 inches
Nailing cleats	32	1x1	5 feet
Nails	2 pounds	10d common	
	2 pounds	8d finish	

Contact the California Redwood Association for more great publications containing redwood technical and building information. Call us at 415 382-0662 for a complete literature list or to ask for any of the titles listed here:

Other Construction Tipsheets	Also Available
Deck Over Concrete	Deck Construction
8x10 Deck	Deck Grades, Nails and Finishes
Deck Around Tub	Design-A-Deck™ Plans Kit
Windsor Shade Shelter	Fences for All Reasons
Butcherblock Bench	Exterior Finishes
4x4 Planter	Landscape Architecture
Sonoma Picnic Table	
Mendocino Bench	

### Redwood

For beauty and performance, redwood is naturally superior to other woods. That's why it's the first choice for decks, fences and most outdoor projects. Redwood retains its beauty outdoors, shrinks and swells less than other woods and is less likely to warp, split, check or cup. With little or no pitch, redwood is easy to drill, saw and shape. Redwood heartwood has natural durability and resistance to insects and will last longer outdoors than most woods.

### Grades

The knotty garden grades of redwood are ideal for outdoor projects. These grades are beautiful, durable and economical.

**Construction Heart/Deck Heart** is all heartwood and contains knots; used for load-bearing applications near the ground.

Deck Heart is graded for strength and is available in 2x4 and 2x6.

**Construction Common/Deck Common** contains sapwood and knots; used for decking and above-ground uses. Deck Common is graded for strength and is available in 2x4 and 2x6.

**Merchantable Heart** is all heartwood and contains larger knots than Construction grades; used near the soil.

**Merchantable** contains sapwood and larger knots; used for fence boards, rails and above-ground uses.

### Finishes

Redwood accepts finishes better than most woods. Some heighten redwood's natural beauty, bringing out the color and the grain. Others help the wood harmonize or contrast with surrounding structures. Keep in mind that unfinished redwood will gradually turn soft driftwood gray. Read the labels on all finish products before using.

**Clear water repellent finish** with mildewcide is recommended to stabilize the color at tan.

**Bleaching and weathering stains** produce a permanent driftwood gray effect, a good, low-maintenance option.

**Semitransparent stains** in "redwood" shades tint the wood without hiding the grain.

**Solid-color stains or paints** should be applied over compatible oil-based primers.

### Fasteners

Use only non-corrosive hardware such as aluminum, stainless steel or top quality hot-dipped galvanized screws or nails. Ordinary nails and screws will cause stains.



405 Enfrente Drive, Suite 200  
Novato, CA 94949-7206  
Telephone 415 382-0662  
Toll Free 888 Cal-Redwood  
Fax 415 382-8531  
[www.calredwood.org](http://www.calredwood.org)